

SINGER
11W8

Registered in U. S. A.

394 RIVER STREET
TROY, N. Y.
594 RIVER STREET
TROY, N. Y.

SINGER

11w8



THE SINGER MANUFACTURING COMPANY

394 RIVER STREET
TROY, N. Y.

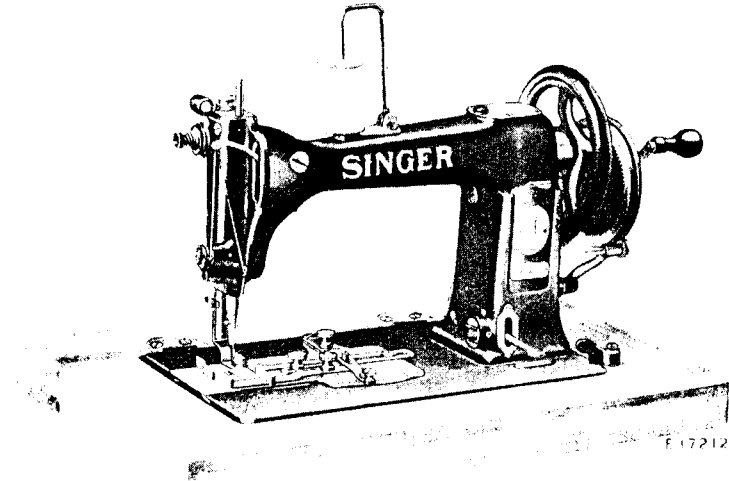

Copyright, U. S. A., 1945
by The Singer Manufacturing Co.
All Rights Reserved for all Countries

14090 - 1/2

205949

202130

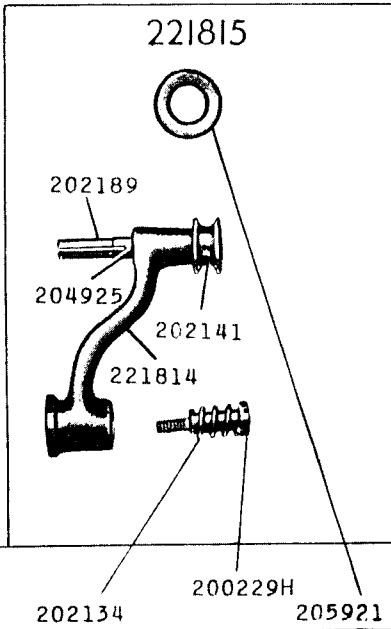
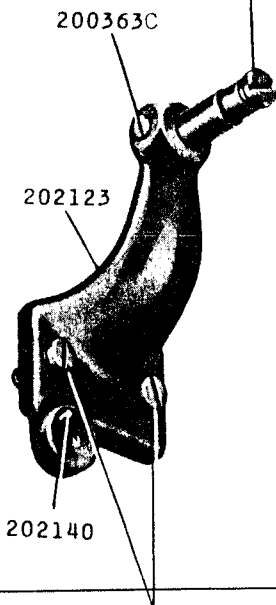
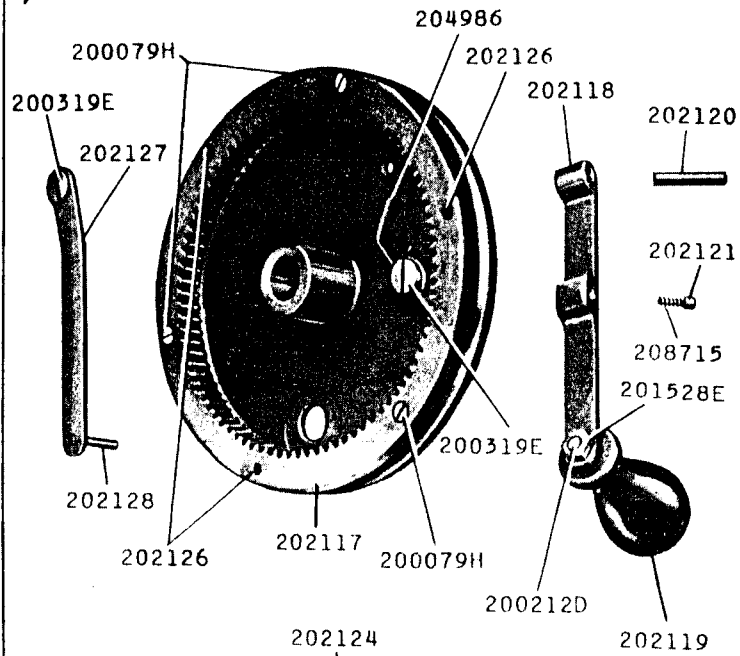

14091 - 1/2

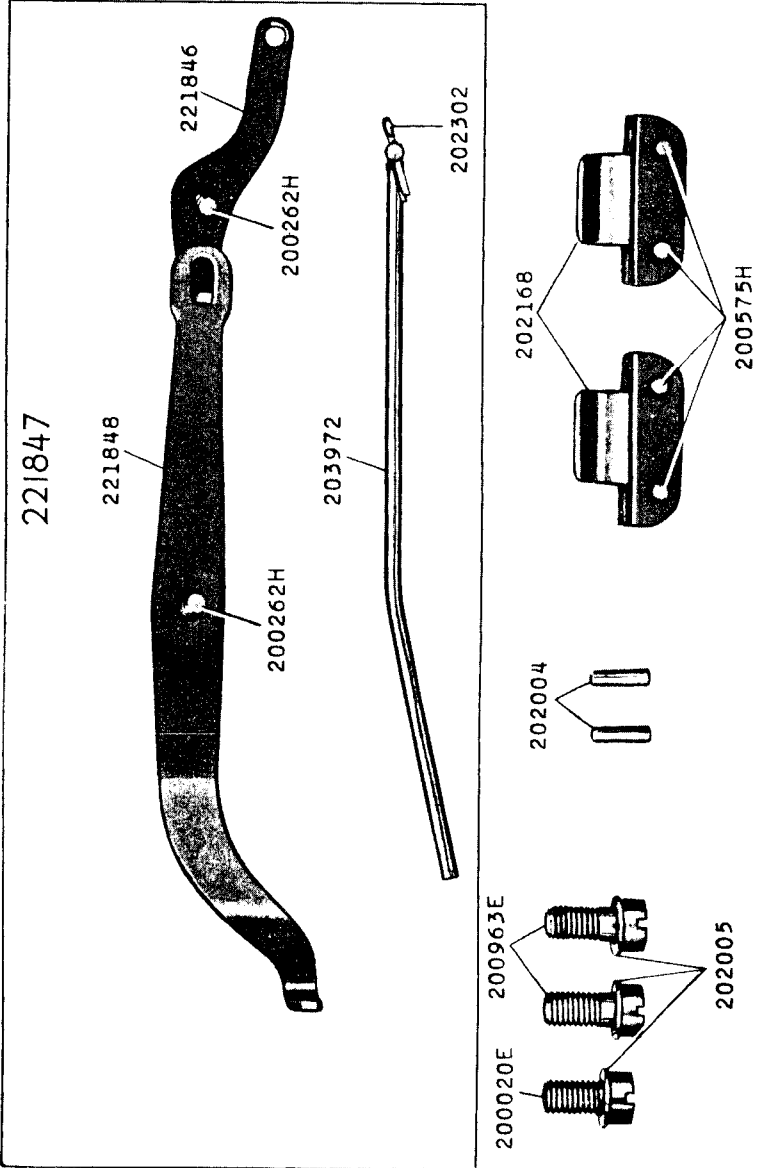

14092 - 3/8

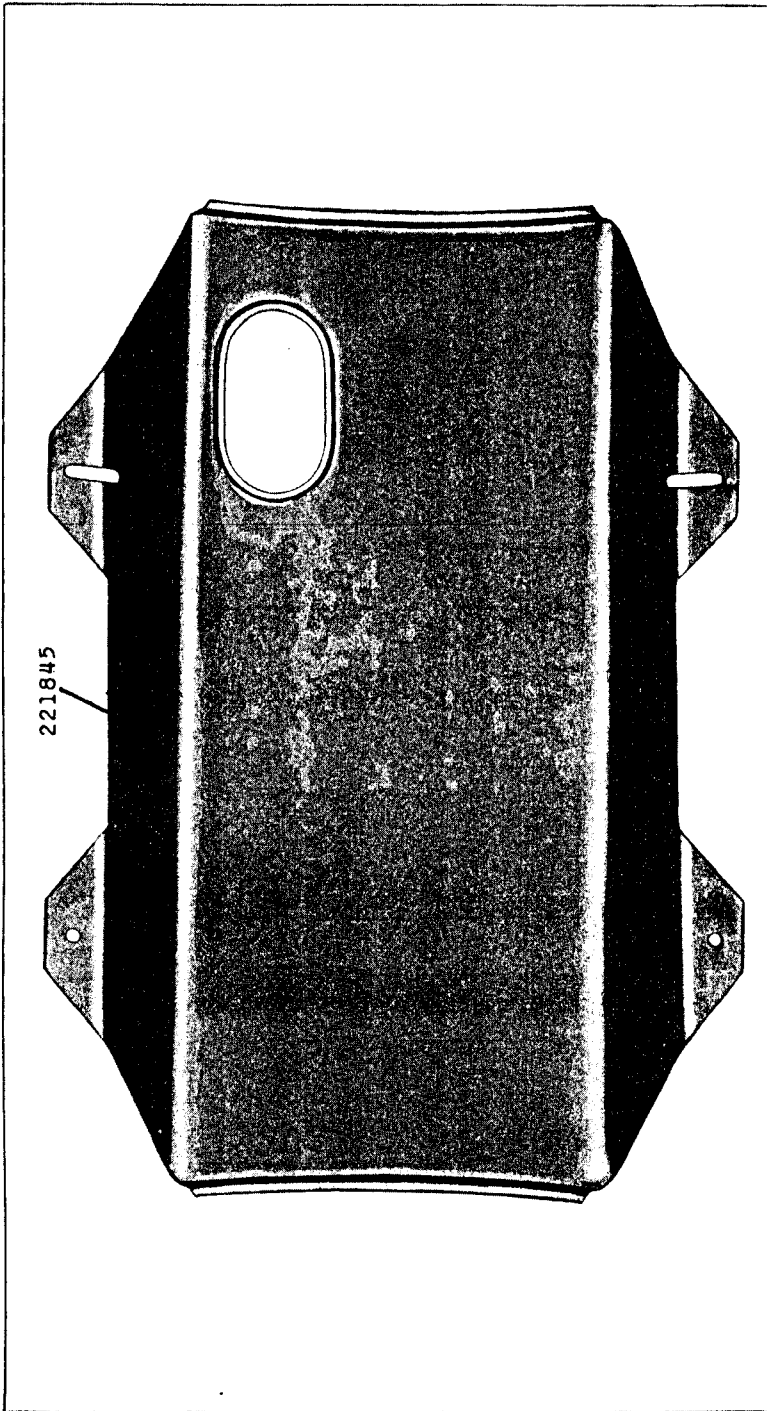

14095 - 3/8

221899

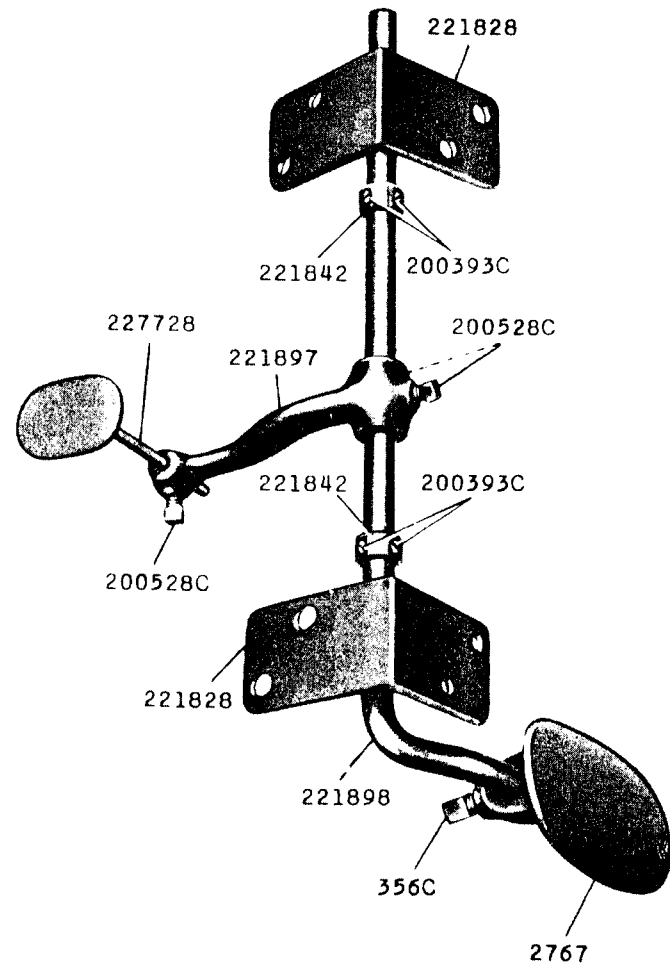

14096 - 1/5

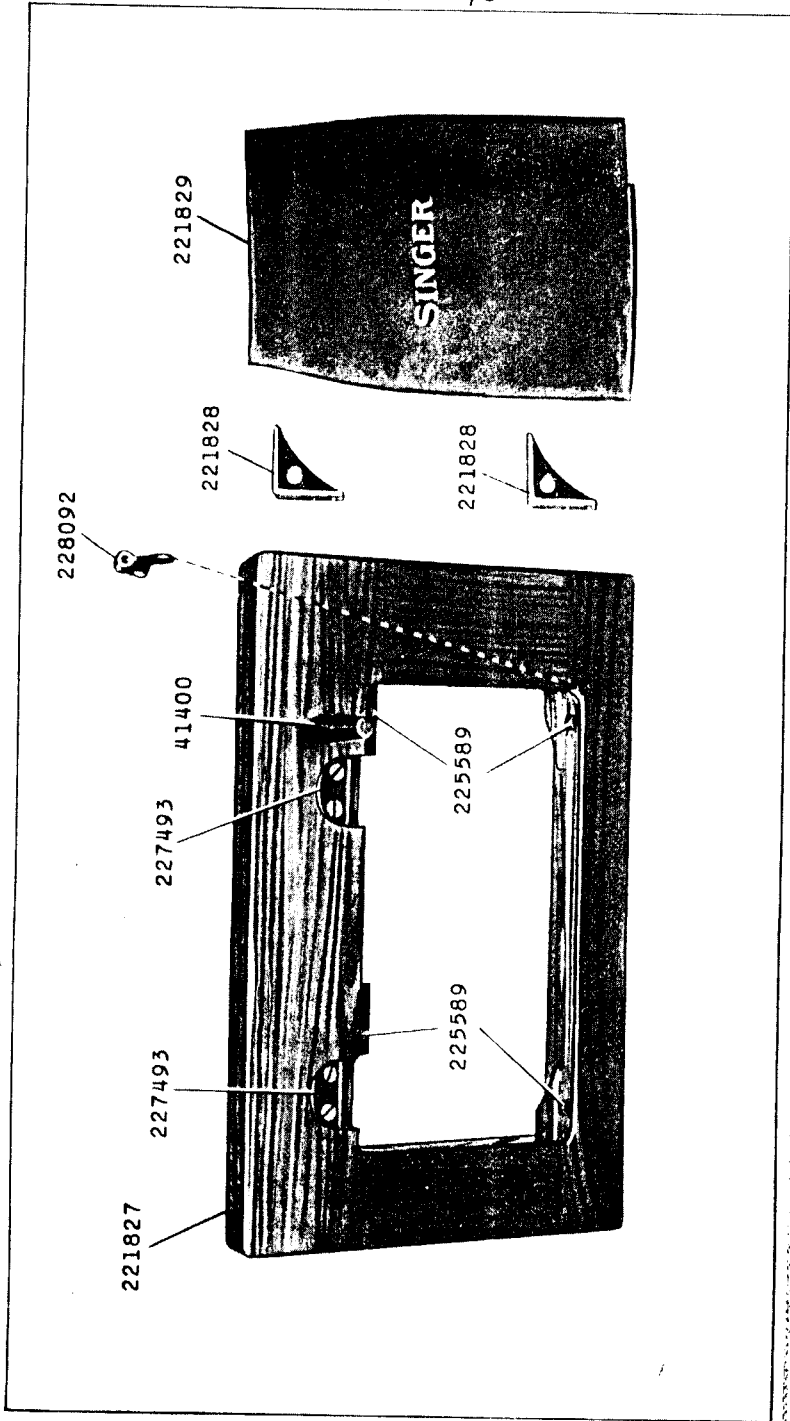

14097 - 1/2

